

CD-S1000

Super Audio CD Player Lecteur Super Audio CD



HiFi Began with Yamaha

Yamaha's involvement with and passion for music goes back more than a century, to when we built our first reed organ in 1887. Now we are the world's leading producer of pianos and other musical instruments, and are involved with music in many other ways as well. We manufacture professional recording equipment, we design concert halls and we assist artists at concerts with set up and sound tuning.

This knowledge and experience benefits our production of audio components in many ways. We introduced our first HiFi (High Fidelity) turntable in 1955. Thereafter we were one of the first to offer mass-produced, high quality audio equipment, and introduced many legendary stereo components.

We hope you enjoy the genuine HiFi experience of Yamaha Natural Sound.



Excellence in Audio Achievement

1920-
1960s

1922: We introduced a high-quality hand-wound phonograph.

Since 1955, we have released many HiFi components, including turntables, tuners, integrated amplifiers, control amplifiers, power amplifiers and speakers.

NS-20 Monitor Speaker



NS-20



CA-1000

1970s

CA-1000 Integrated Amplifier

Featuring A-Class operation, the CA-1000 set the standard for integrated amplifiers.

NS-690 Monitor Speaker



NS-690



NS-1000M

NS-1000M Monitor Speaker

A truly legendary speaker still revered by HiFi enthusiasts

B-1 Power Amplifier

An innovative power amp that used FETs in all stages



B-1



C-2

C-2 Control Amplifier

Received top prize at the Milan International Music and HiFi Show.

NS-10M Studio Monitor Speaker

Became of the most popular studio monitors in the world.

A-1 Integrated Amplifier

PX-1 Turntable

Yamaha's first linear tracking turntable



PX-1



NS-10M

1980s

B-6 Power Amplifier

Pyramid-shaped power amplifier with X power supply and X amplifier

GT-2000/L Turntable

Ultra-precise heavyweight player embodying GT concept

CD-1 CD Player

First CD Player introduced in 1983

B-2x Power Amplifier

MX-10000 Power Amplifier and

CX-10000 Control Amplifier

Amplifier that redefined the capabilities of separate components

100th anniversary model

AX-2000 Integrated Amplifier

High S/N ratio (128 dB), digital direct function equipped



B-6



GT-2000



AX-2000



GT-CD1

1990s

GT-CD1 CD Player

Top-loading type player with integrated separate structure

MX-1 Power Amplifier and CX-1 Control Amplifier

2000s

Soavo-1 and Soavo-2 Natural Sound Speaker Systems

A-S2000 Stereo Amplifier and CD-S2000 Super Audio CD Player

A-S1000 Stereo Amplifier and CD-S1000 Super Audio CD Player



Soavo-1



Soavo-2

CD-S1000

- ◆ *Symmetrical circuitry using independent left and right power supply circuits and a twin DAC structure for fully independent left and right channels*
- ◆ *Separate power-transformer windings for digital and analog circuitry*
- ◆ *Newly developed high rigidity silent loader and high precision CD drive*
- ◆ *PURE DIRECT*
- ◆ *Super sound from Super Audio CDs*
- ◆ *Newly developed heavyweight feet to suppress vibrations*

■ Supplied accessories

Please check that you have received all of the following parts.

- Power cable
- Remote control
- Batteries (AA, R6, UM-3) (×2)
- Audio pin cable
- Safety brochure

Contents

Controls and functions.....	6
Connections.....	14
Specifications	18
Playable disc format.....	19
Troubleshooting.....	21

■ About this manual

- ※ indicates a tip for your operation.
- This manual is printed prior to production. Design and specifications are subject to change in part as a result of improvements, etc. In case of differences between the manual and the product, the product has priority.
- The color of images in this manual may vary from the original.
- Read the “Safety brochure” before using this unit.

CD-S1000

Controls and functions

In this chapter, you will learn the controls and functions of CD-S1000.

POWER
ON



OFF



COMPACT
disc
DIGITAL AUDIO



SUPER AUDIO CD

■ Front panel

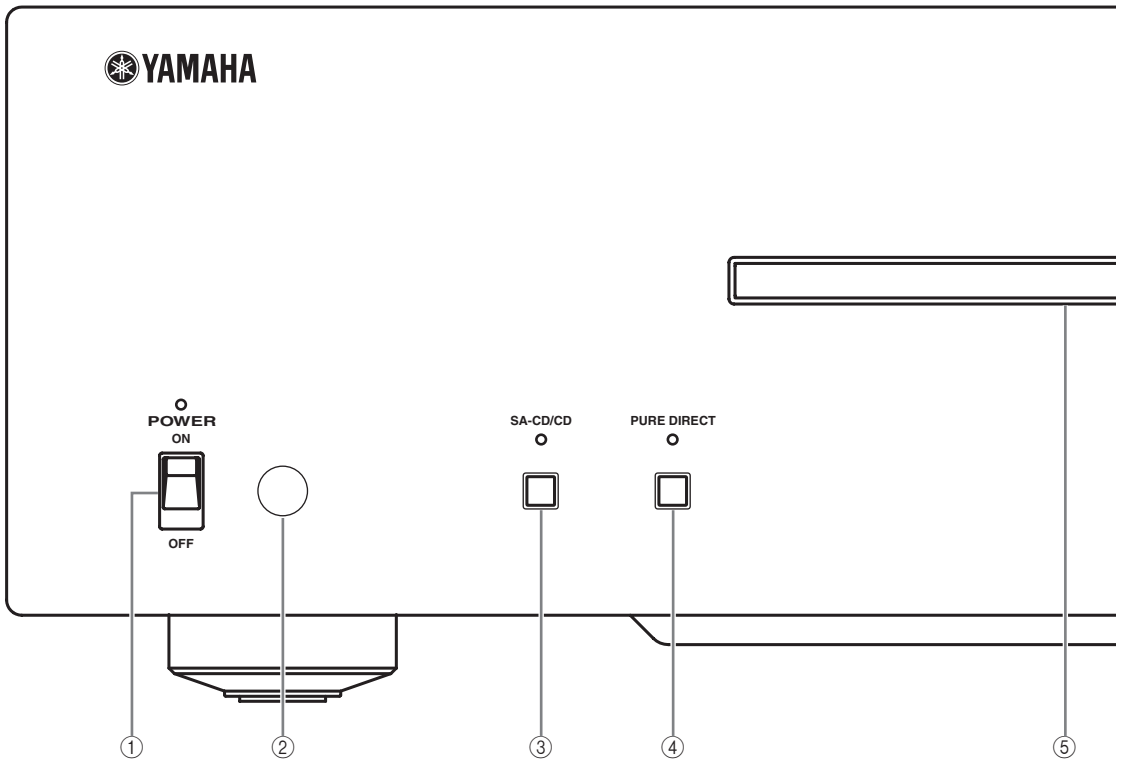

① POWER

Press upward or downward to turn on or off this unit.



- The POWER indicator above lights up when this unit is turned on.
- Playback starts automatically if the power is turned on while a disc is set in the disc tray.

② Remote control sensor

Receives signals from the remote control.

③ SA-CD/CD

Switches the playback layer of a hybrid SA-CD between SA-CD and CD (see page 19).



- The SA-CD/CD indicator above lights up when the SA-CD layer is selected.
- This setting is retained even if you turn off this unit.

Notes

- Audio signals are only output from the ANALOG OUT jacks while the Super Audio CD layer is selected.
- Audio signals recorded in DSD multi-channel format cannot be played on this unit.

④ PURE DIRECT

Turns on the PURE DIRECT mode to improve audio quality.

When this unit is in the PURE DIRECT mode:

- The PURE DIRECT indicator above lights up.
- Audio signals are not output at the OPTICAL DIGITAL OUT jack and the COAXIAL DIGITAL OUT jack (see page 8).
- The front panel display is turned off and only the minimum required indicators and messages are displayed.



- Press again to turn off the PURE DIRECT mode.
- This setting is retained even if you turn off this unit.

⑤ Disc tray

Loads a disc.

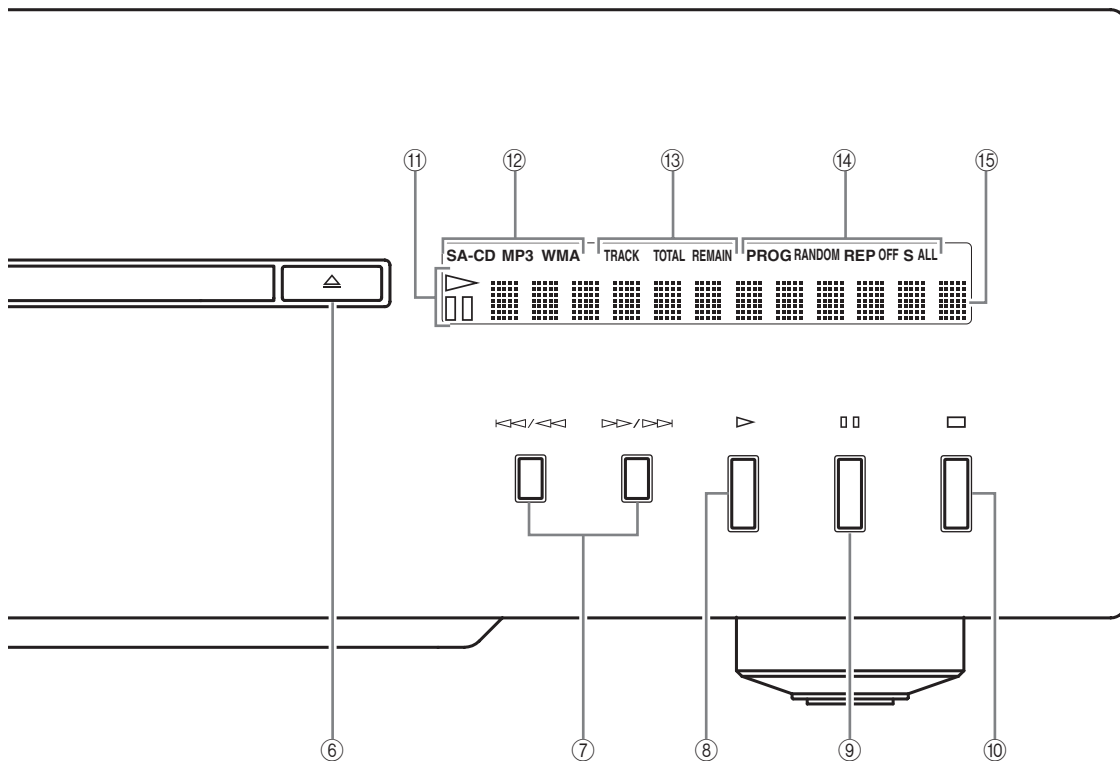

⑥ **△ (Open/Close)**

Opens or closes the disc tray.



You can also close the disc tray by:

- pressing ▷ (Play) on the front panel or on the remote control or by pushing the front edge of the disc tray gently.
- pressing a numeric button on the remote control.

⑦ **⏮/⏪ (Skip/Search backward),
⏩/⏭ (Skip/Search forward)**

⏩/⏭ : Skips to the next track.

⏮/⏪ : Skips back to the beginning of the current track.

⏮/⏪ (twice): Skips to the previous track.

Press and hold ⏮/⏪ or ⏩/⏭ to search backward/forward.



Each time you press and hold ⏮/⏪ or ⏩/⏭, the search speed increases by 4 levels.

⑧ **▷ (Play)**

Starts playback.

⑨ **⏸ (Pause)**

Pauses playback. Press ▷ or ⏸ to resume playback.

⑩ **⏹ (Stop)**

Stops playback.

⑪ **Playback status indicator**

Lights up when this unit is in the play or pause mode.

⑫ **Disc type indicator**

Indicates the type of disc set in the disc tray.

⑬ **Time display mode indicator**

See “DISPLAY” (page 11) for details.

⑭ **Playback mode indicator**

See “REPEAT” (page 10), “RANDOM” (page 11), and “PROGRAM” (page 11) for details.

⑮ **Multi-information display**

See pages 20 for more information on MP3/WMA playback.

■ Rear panel

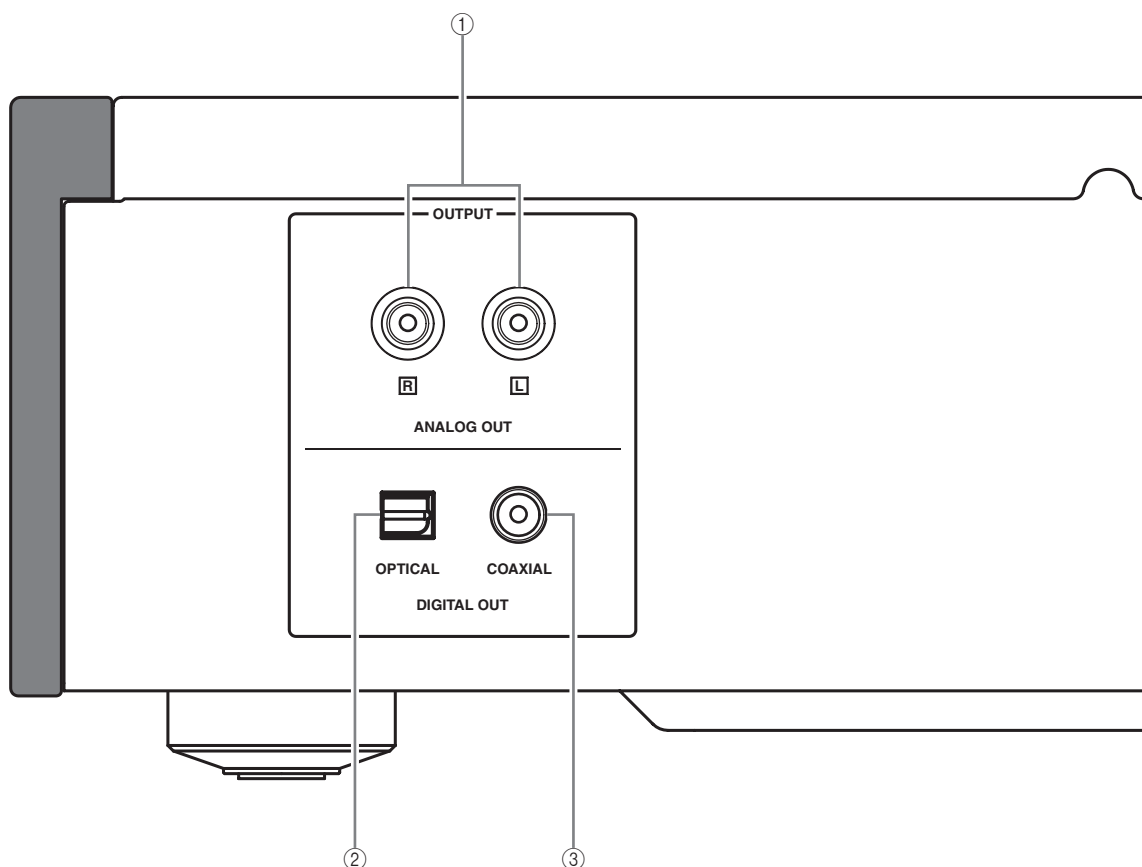

See page 14 for connection information.

- ① **ANALOG OUT jacks**
- ② **OPTICAL DIGITAL OUT jack**
- ③ **COAXIAL DIGITAL OUT jack**

Note

The audio signals are only output from the ANALOG OUT jacks while the Super Audio CD layer is selected or when the PURE DIRECT mode is on.

(Asia and General models)

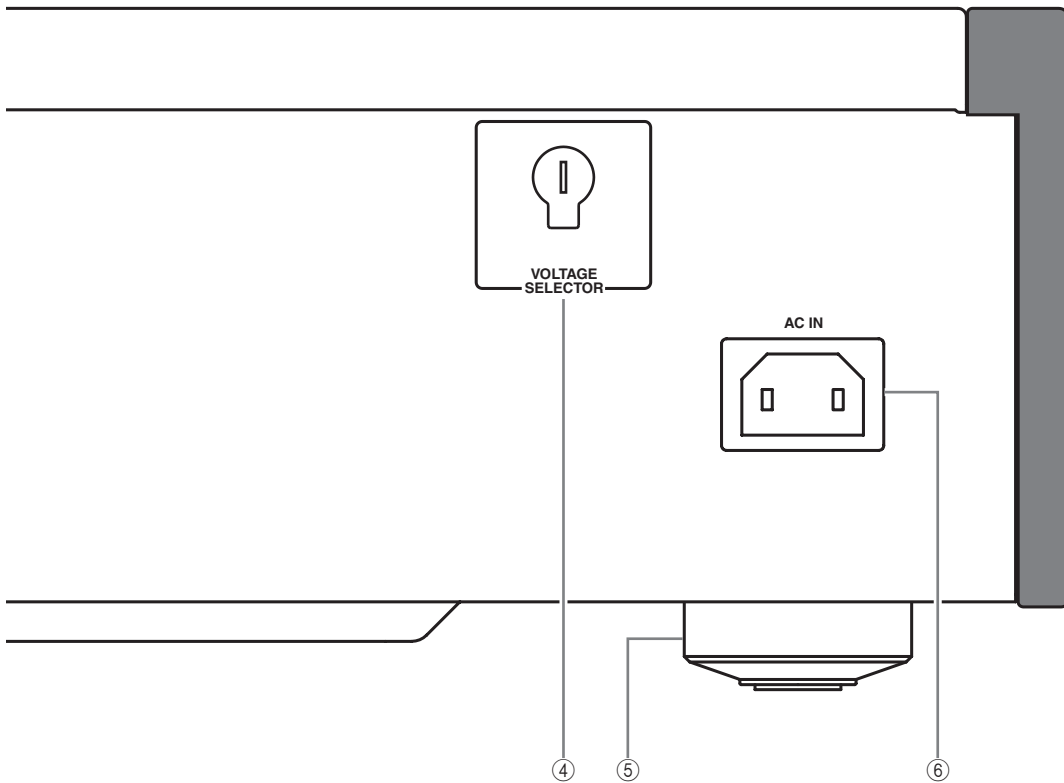

④ **VOLTAGE SELECTOR**

(Asia and General models only)

The **VOLTAGE SELECTOR** on the rear panel of this unit must be set for your local main voltage **BEFORE** plugging the power cable into the AC wall outlet. See page 15 for further information.

⑤ **Foot**

If this unit is unstable, you can adjust the foot height by rotating it.

⑥ **AC IN**

Use this inlet to plug in the supplied power cable. See page 15 for connection information.

■ Remote control

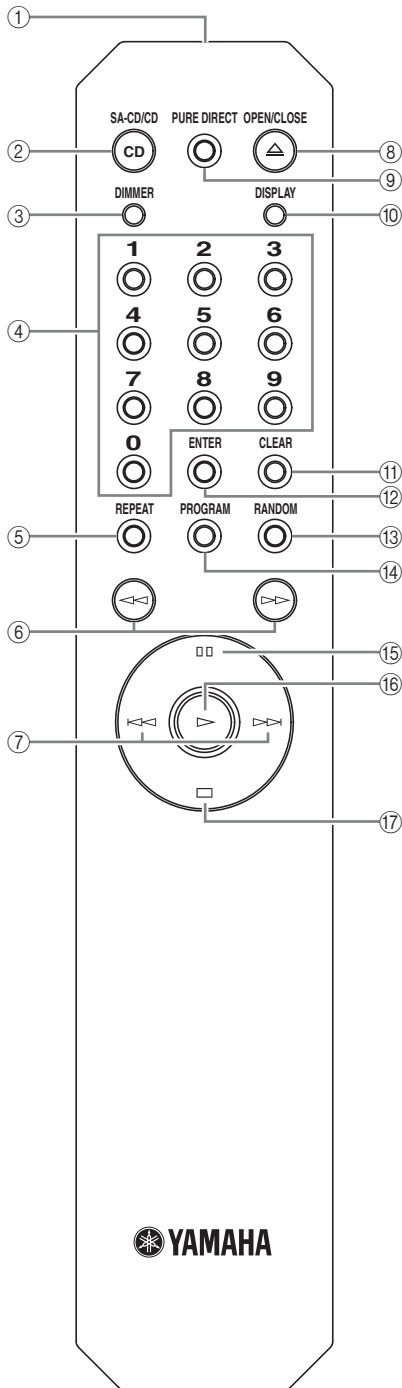

① Infrared signal transmitter

Sends infrared signals to this unit.

② SA-CD/CD

Switches the playback layer of a hybrid SA-CD between SA-CD and CD (see page 19).



- The SA-CD/CD indicator on the front panel lights up when the SA-CD layer is selected.
- This setting is retained even if you turn off this unit.

Notes

- Audio signals are only output from the ANALOG OUT jacks while the Super Audio CD layer is playing.
- Audio signals recorded in DSD multi-channel format cannot be played on this unit.

③ DIMMER

Selects brightness level for the front panel display. Each time you press DIMMER, the brightness level changes in the following order.

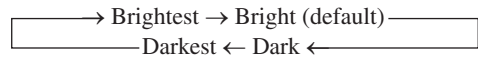

This setting is retained even if you turn off this unit.

④ Numeric buttons

Use to select a track directly.

Note

This operation is ineffective for MP3 or WMA discs.

⑤ REPEAT

Repeats playback of a single track or all tracks. Each time you press REPEAT during playback, the repeat playback mode changes as follows:

- REP S (single repeat playback): On reaching the end of the current track, playback repeats from the beginning of the current track.
- REP ALL (all repeat playback): On reaching the end of the last track, playback repeats from the beginning of the first track.

Note

This operation is ineffective for MP3 or WMA discs.

- ⑥ ◀◀ (**Search backward**), ▶▶ (**Search forward**)
Searches tracks backward/forward.



Each time you press ◀◀ or ▶▶, the search speed increases by 4 levels.

- ⑦ ◀◀ (**Skip backward**), ▶▶ (**Skip forward**)
▶▶ : Skips to the next track.
◀◀ : Skips back to the beginning of the current track.
◀◀ (twice): Skips to the previous track.

- ⑧ **OPEN/CLOSE**
Opens or closes the disc tray.

- ⑨ **PURE DIRECT**
Turns on the PURE DIRECT mode to improve audio quality.
When this unit is in the PURE DIRECT mode:
- The PURE DIRECT indicator above lights up.
 - Audio signals are not output at the OPTICAL DIGITAL OUT jack and the COAXIAL DIGITAL OUT jack (see page 8).
 - The front panel display is turned off and only the minimum required indicators and messages are displayed.



This setting is retained even if you turn off this unit.

- ⑩ **DISPLAY**
Switches the time display. Each time you press DISPLAY during playback, the time display changes as follows:
- Elapsed time of the current track (default setting): The TRACK indicator lights up in the front panel display.
 - Remaining time of the current track: The TRACK and REMAIN indicators light up in the front panel display.
 - Total remaining time of the disc: The TOTAL and REMAIN indicators light up in the front panel display.

- ⑪ **CLEAR**
Erases the last programmed track when this unit is in the program editing mode. See “Program playback” on this page.



You can erase all programmed tracks when the playback is stopped.

- ⑫ **ENTER**
Confirms a track number entered when you are programming tracks.

- ⑬ **RANDOM**
Turns on or off the random playback mode.

Notes

- This operation is ineffective for MP3 or WMA discs.
- The random playback mode is canceled when playback is stopped or the disc is ejected.

- ⑭ **PROGRAM**
Turns on or off the program playback mode. See “Program playback” on this page.

- ⑮ ◻◻ (**Pause**)
Pauses playback. Press ▷ or ◻◻ to resume playback.

- ⑯ ▷ (**Play**)
Starts playback.

- ⑰ ◻ (**Stop**)
Stops playback.

See pages 20 for more information on MP3/WMA playback.

■ Program playback

In the program playback mode, you can play back tracks in a programmed sequence.

Notes

- This operation is ineffective for MP3 or WMA discs.
- The programmed tracks are erased when the disc is ejected or this unit is turned off.

- 1 Press PROGRAM while playback is stopped.**
This unit is set to the program editing mode.
- 2 Select a track by using the numeric buttons and ENTER.**
- 3 Repeat step 2 to program the next track.**
You can program up to 24 tracks.
- 4 Press ▷.**
Playback starts from the beginning of the programmed sequence.

■ Installing batteries in the remote control

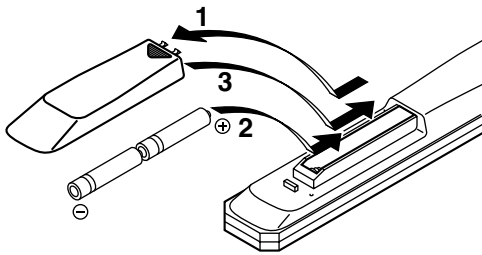

- 1** Press the ▼ part and slide the battery compartment cover off.
- 2** Insert the two supplied batteries (AA, R6, UM-3) according to the polarity markings (+ and -) on the inside of the battery compartment.
- 3** Slide the cover back until it snaps into place.

■ Using the remote control

The remote control transmits a directional infrared beam. Be sure to aim the remote control directly at the remote control sensor on the front panel of this unit during operation.

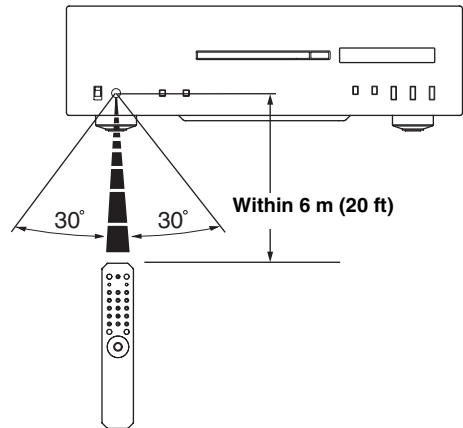

A black and white photograph showing a close-up of the rear panel of a CD-S1000 device. The panel features several connection points: two large analog output jacks at the top, a square optical output port in the middle, and a coaxial output jack at the bottom right. The text 'ANALOG OUT' is printed above the optical port, 'OPTICAL' is printed below it, and 'COAXIAL' is printed below the coaxial jack. A small square icon with the letter 'L' is visible to the right of the analog jacks. The background is dark, and the lighting highlights the metallic surfaces of the connectors.

CD-S1000 Connections

In this section, you will make connections between CD-S1000 and your amplifier.

ANALOG OUT

OPTICAL

COAXIAL

DIGITAL

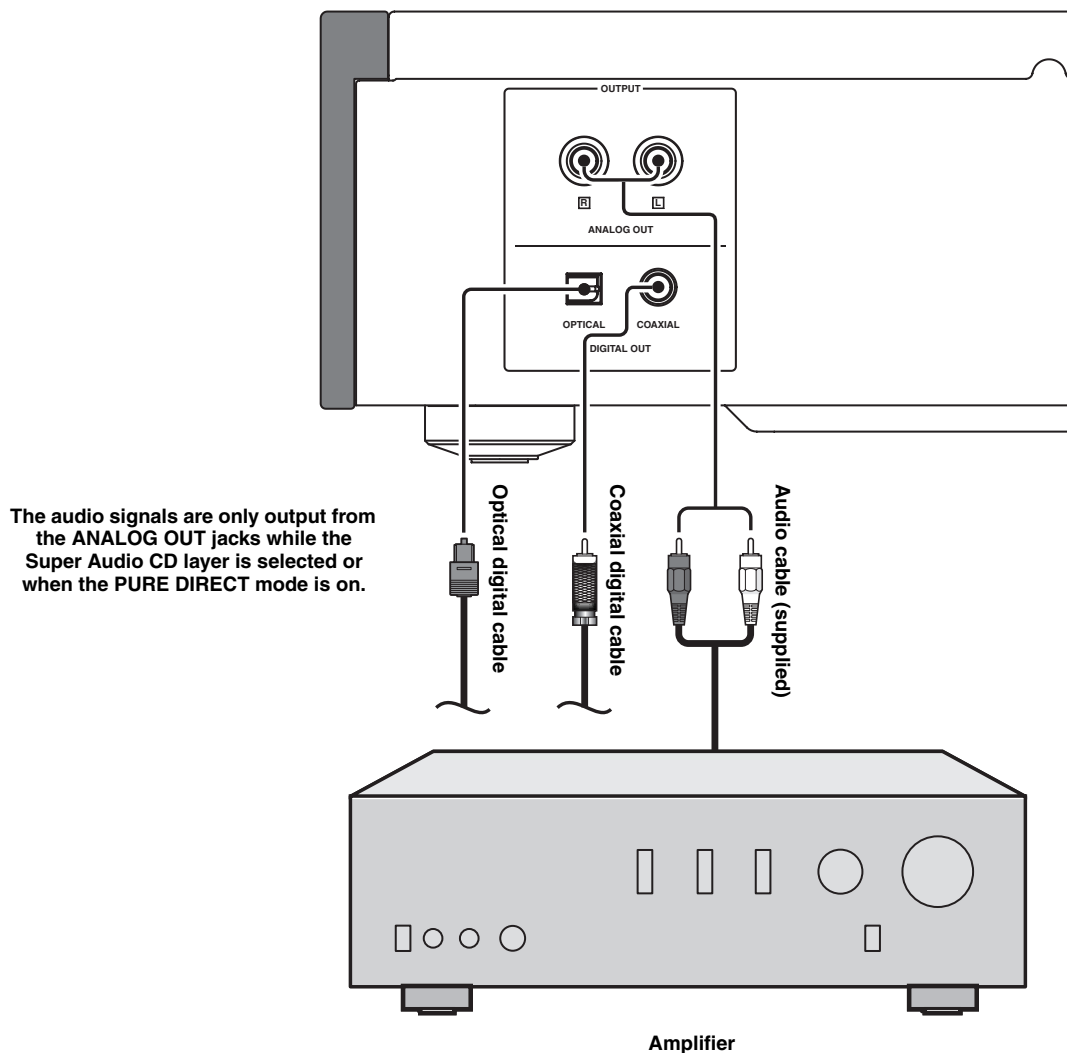

(Asia and General models)

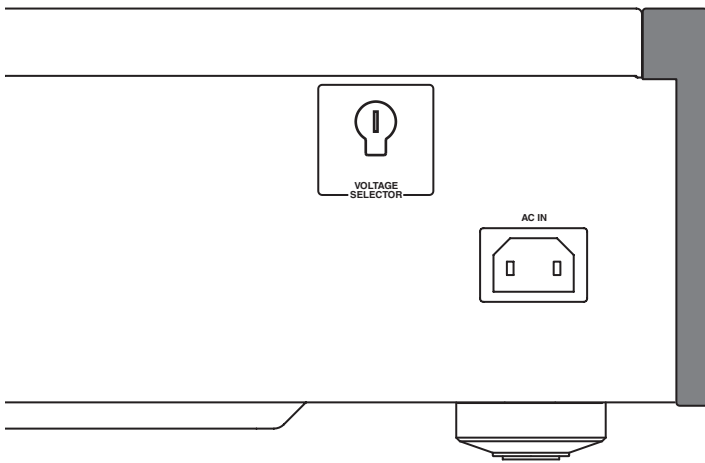

■ **VOLTAGE SELECTOR**
(Asia and General models only)

Caution

The VOLTAGE SELECTOR on the rear panel of this unit must be set for your local voltage BEFORE plugging the power cable into the AC wall outlet. Improper setting of the VOLTAGE SELECTOR may cause damage to this unit and create a potential fire hazard.

Rotate the VOLTAGE SELECTOR clockwise or counterclockwise to the correct position using a straight slot screwdriver.

Voltages are as follows:

.....AC 110/120/220/230–240 V, 50/60 Hz

■ **Connecting the power cable**

Connect the power cable into the AC IN inlet on the rear panel when all connections are complete, and then plug in the power cable to the AC outlet.

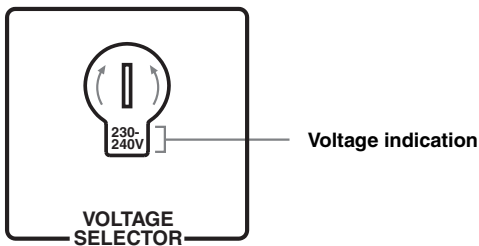

■ **CD-S1000 input/output table**

Output jacks	Disc	SA-CD			CD	MP3/WMA	Note
		DSD stereo layer	DSD multi-channel layer	CD layer			
ANALOG OUT		✓	–	✓	✓	✓	
DIGITAL OUT (OPTICAL and COAXIAL)		–	–	✓	✓	✓	No signal is output when this unit is in the PURE DIRECT mode.

CD-S1000

Specifications

AUDIO SECTION

- Frequency Response
 - SA-CD 2 Hz to 50 kHz (-3 dB)
 - CD 2 Hz to 20 kHz
- Total Harmonic Distortion (1 kHz)
 - SA-CD, CD 0.002% or less
- Signal to Noise Ratio (IHF-A Network) 113 dB or more
- Dynamic Range
 - SA-CD 105 dB or more
 - CD 100 dB or more
- Output Level (1 kHz, 0 dB) 2.0 ± 0.3 V

LASER DIODE PROPERTIES

- Type
 - SA-CD Semiconductor laser (AlGaInP)
 - CD Semiconductor laser (AlGaAs)
- Wavelength
 - SA-CD 650 nm
 - CD 780 nm
- Output Power
 - SA-CD 5 mW (max)
 - CD 7 mW (max)

GENERAL

- Power Supply
 - [U.S.A. and Canada models] AC 120 V, 60 Hz
 - [Asia and General models] AC 110/120/220/230-240 V, 50/60 Hz
 - [China model] AC 220 V, 50 Hz
 - [Korea model] AC 220 V, 60 Hz
 - [Australia model] AC 240 V, 50 Hz
 - [U.K. and Europe models] AC 230 V, 50 Hz
- Power Consumption 30 W
- Off-state Power Consumption 0 W
- Dimensions (W x H x D) 435 x 137 x 440 mm
(17-1/8" x 5-3/8" x 17-5/16")
- Weight 15 kg (33 lbs. 1 oz.)

* Specifications are subject to change without notice.

Taking care of this unit

When you wipe this unit, do not use chemical solvents (ex. alcohol or thinner etc.); this might damage the finish. Use a clean, dry cloth. For heavy dirt, dampen a soft cloth in detergent diluted with the water, wring it out, and then clean this unit up with the cloth.

The screws on the side panels may loosen as wood expands and contracts. In this case, tighten the screws.

Supported disc types

This unit is designed to play back compact discs bearing the marks shown below. Never attempt to load any other types of discs into this unit. This unit can also play back 8-cm (3-inch) compact discs.

Super Audio CD



SUPER AUDIO CD

Audio format based upon the current CD standards but includes a greater amount of information that provides higher quality sound. There are three types of discs: single layer, dual layer and hybrid layer discs. The hybrid disc can be played on conventional CD players as well as Super Audio CD players since it contains both standard audio CD and Super Audio CD information.

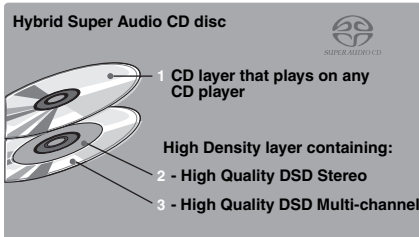
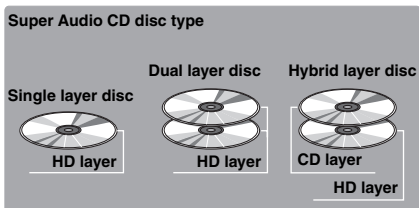

Notes

- This unit does not show the text data included in the discs on the front panel display.
- Audio signals recorded in DSD multi-channel format cannot be played on this unit.

Compact discs (digital audio)



The most popular discs for commercially available audio CDs.

CD-R, CD-RW digital audio discs



Music CDs made by copying onto a CD-R or CD-RW (including MP3 or WMA format files).

Notes

- Be sure to use a CD-R or CD-RW disc made by a reliable manufacturer.
- Be sure to use a CD-R or CD-RW disc which has at least one of the following phrases on the disc or disc case.
 - FOR CONSUMER
 - FOR CONSUMER USE
 - FOR MUSIC USE ONLY
- Be sure to use a finalized CD-R or CD-RW disc.

CD-TEXT discs



Discs on which text data (album titles, track titles, artist names, etc.) are recorded. This unit is compatible with audio playback of CD-TEXT discs.

Note

This unit does not show the text data included in the discs on the front panel display.

NOTE:

This unit may not be able to play back some CD-RW discs or discs on which recording was not made correctly.

To prevent a malfunction of this unit:

- Do not use any nonstandard shaped disc (heart, etc.) available in the market as it might damage this unit.
- Do not use a disc with tape, seals, or paste on it. Such a disc may get stuck in this unit or cause damage to this unit.

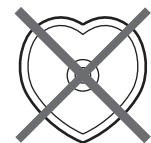

■ About MP3 and WMA discs

You can play back MP3 and WMA files recorded on a CD-R or CD-RW with similar uses as a music CD.

MP3

MP3 (MPEG-1 Audio Layer-3) is a standard technology and format for compressing an audio sequence into a small-sized file. However, the original level of sound quality is preserved during playback.

Notes

- This unit plays back MP3 files in alphanumeric order.
- Up to 648 folders and files (combined) and up to 299 folders are recognized; however, some folders and files may not be recognized depending on their directory structure.
- Depending on recording conditions such as recording software settings, this unit may not be able to play back the disc or files in the order they were recorded.
- This unit is compatible with a sampling frequency of 44.1 kHz.
- This unit is compatible with a bitrate of 32, 40, 48, 56, 64, 80, 96, 112, 128, 160, 192, 224, 256, or 320 kbps. Variable bitrate is not supported.
- The disc must be ISO9660 compatible.
- The text data contained in the files are not displayed on this unit.

WMA

WMA (Windows Media Audio) is a Microsoft file format for encoding digital audio files similar to MP3 although WMA can compress files at a higher rate than MP3.

Notes

- This unit plays back WMA files in alphanumeric order.
- Up to 648 folders and files (combined) and up to 299 folders are recognized; however, some folders and files may not be recognized depending on their directory structure.
- Depending on recording conditions such as recording software settings, this unit may not be able to play back the disc or files in the order they were recorded.
- This unit is compatible with a sampling frequency of 44.1 kHz.
- This unit is compatible with a bitrate of 48, 64, 80, 96, 128, 160, or 192 kbps. Variable bitrate is not supported.
- The disc must be ISO9660 compatible.
- Copyright-protected WMA files cannot be played back with this unit.
- The text data contained in the files are not displayed on this unit.

■ Handling compact discs

- Always handle a disc with care so that its surface is not scratched.



- Compact discs are rarely worn out during playback, but damage to the disc surface when the disc is being handled can adversely affect the disc playback.
- Be sure to use a felt-tip pen or similar writing tool when writing on the label side of a disc. Do not use a ball-point pen, pencil, or other hard-tipped writing tools as these may damage the disc and may adversely affect the disc playback.
- Do not warp discs.
- When a disc is not currently being used, remove it from this unit and store it in an appropriate case.
- When removing or storing a disc, be careful not to scratch the playing surface.
- Compact discs are not affected by small particles of dust or fingerprints on their playing surface, but even so they must be kept clean. Wipe the disc surface with a clean, dry cloth. Do not wipe the disc surface with a circular motion; wipe it straight outward from the center.

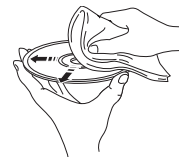

- Do not try to clean the disc surface with any type of disc cleaner, record spray, anti-static spray or liquid, or any other chemical-based liquid as such substances may irreparably damage the disc surface.
- Do not expose discs to direct sunlight, high temperature, or high humidity for a long period of time as these conditions may warp or otherwise damage the disc.

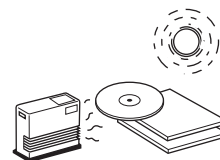

- To play back an 8-cm (3-inch) compact disc, place it in the inner recessed area of the disc tray. Do not put a normal 12-cm CD on top of an 8-cm CD.

Refer to the chart below if this unit does not function properly. If the problem you are experiencing is not listed below or if the instructions below do not help, turn off this unit, disconnect the power cable, and contact the nearest authorized Yamaha dealer or service center.

Problem	Cause	Remedy	See page
This unit fails to turn on.	The power cable is not connected to the AC IN inlet on the rear panel or not plugged in the AC wall outlet.	Connect the power cable firmly.	15
The disc tray does not close completely.	A foreign object is obstructing the tray.	Carefully check the disc tray and remove the foreign object.	—
Playback does not start.	The disc is damaged.	Check the disc carefully; replace it if necessary.	—
	There is moisture on the laser pickup.	Wait 20 to 30 minutes after switching on the unit ON before trying to play back a disc.	—
	The disc is loaded upside down.	Reload the disc with the label side up.	—
	The disc is dirty.	Clean the disc.	20
	The MP3 or WMA formats are not compatible with this unit.	Replace the disc with a correctly recorded disc playable with this unit.	20
	The CD-RW (ReWritable) disc is not recorded correctly.	Replace the disc with a correctly recorded disc playable with this unit.	19
	The disc is a non-standard disc not playable with this unit.	Replace the disc with a correctly recorded disc playable with this unit.	19
Playback is delayed, or begins at the wrong place.	The disc may be scratched or damaged.	Check the disc carefully; replace it if necessary.	20
No sound.	Improper output cable connections.	Connect the cables properly. If the problem persists, the cables may be defective.	14
	Improper amplifier operation.	Set the amplifier controls to the correct input selection.	—
Sound of a component connected to the DIGITAL OUT jacks is not played.	PURE DIRECT is turned on.	Turn PURE DIRECT off. Or make an analog connection.	6
	Super Audio CD layer is playing.	Switch the playback layer. Or make an analog connection.	6, 10
Sound “skips”.	This unit is being subjected to vibrations or impacts.	Relocate this unit.	—
	The disc is dirty.	Clean the disc.	20
Sound “hums”.	Improper cable connections.	Securely connect the audio cables. If the problem persists, the cables may be defective.	14
Noise from a nearby tuner.	The tuner is too close to this unit.	Move the tuner and this unit farther apart.	—
Noise from inside of the disc tray.	The disc may be warped.	Replace the disc.	—

Problem	Cause	Remedy	See page
The remote control does not work or function properly.	Wrong distance or angle.	The remote control functions within a maximum range of 6 m (20 ft) and no more than 30 degrees off-axis from the front panel.	12
	Direct sunlight or lighting (from an inverter type of fluorescent lamp, etc.) is striking the remote control sensor of this unit.	Reposition this unit.	—
	The batteries are weak.	Replace all batteries.	12



© 2008 YAMAHA CORPORATION All rights reserved.



YAMAHA ELECTRONICS CORPORATION, USA 6660 ORANGETHORPE AVE., BUENA PARK, CALIF. 90620, U.S.A.
YAMAHA CANADA MUSIC LTD. 135 MILNER AVE., SCARBOROUGH, ONTARIO M1S 3R1, CANADA
YAMAHA ELECTRONIK EUROPA G.m.b.H. SIEMENSSTR. 22-34, 25462 RELLINGEN BEI HAMBURG, GERMANY
YAMAHA ELECTRONIQUE FRANCE S.A. RUE AMBROISE CROIZAT BP70 CROISSY-BEAUBOURG 77312 MARNE-LA-VALLEE CEDEX02, FRANCE
YAMAHA ELECTRONICS (UK) LTD. YAMAHA HOUSE, 200 RICKMANSWORTH ROAD WATFORD, HERTS WD18 7GQ, ENGLAND
YAMAHA SCANDINAVIA A.B. J A WETTERGRENS GATA 1, BOX 30053, 400 43 VÄSTRA FRÖLUNDA, SWEDEN
YAMAHA MUSIC AUSTRALIA PTY. LTD. LEVEL 1, 99 QUEENSBRIDGE STREET, SOUTHBANK, VIC 3006, AUSTRALIA

YAMAHA CORPORATION
Printed in Malaysia ◀ WN63170

Super Audio CD Player
Lecteur Super Audio CD

SAFETY BROCHURE
BROCHURE SUR LA SECURITE

IMPORTANT SAFETY INSTRUCTIONS

	CAUTION RISK OF ELECTRIC SHOCK DO NOT OPEN	
CAUTION: TO REDUCE THE RISK OF ELECTRIC SHOCK, DO NOT REMOVE COVER (OR BACK). NO USER-SERVICEABLE PARTS INSIDE. REFER SERVICING TO QUALIFIED SERVICE PERSONNEL.		

• Explanation of Graphical Symbols



The lightning flash with arrowhead symbol, within an equilateral triangle, is intended to alert you to the presence of uninsulated “dangerous voltage” within the product’s enclosure that may be of sufficient magnitude to constitute a risk of electric shock to persons.



The exclamation point within an equilateral triangle is intended to alert you to the presence of important operating and maintenance (servicing) instructions in the literature accompanying the appliance.

IMPORTANT

Please record the serial number of this unit in the space below.

MODEL:

Serial No.:

The serial number is located on the rear of the unit. Retain this Owner’s Manual in a safe place for future reference.

FOR CANADIAN CUSTOMERS

To prevent electric shock, match wide blade of plug to wide slot and fully insert.

This Class B digital apparatus complies with Canadian ICES-003.

- 1 Read these instructions.
- 2 Keep these instructions.
- 3 Heed all warnings.
- 4 Follow all instructions.
- 5 Do not use this apparatus near water.
- 6 Clean only with dry cloth.
- 7 Do not block any ventilation openings. Install in accordance with the manufacturer’s instructions.
- 8 Do not install near any heat sources such as radiators, heat registers, stoves, or other apparatus (including amplifiers) that produce heat.
- 9 Do not defeat the safety purpose of the polarized or grounding-type plug. A polarized plug has two blades with one wider than the other. A grounding type plug has two blades and a third grounding prong. The wide blade or the third prong are provided for your safety. If the provided plug does not fit into your outlet, consult an electrician for replacement of the obsolete outlet.
- 10 Protect the power cord from being walked on or pinched particularly at plugs, convenience receptacles, and the point where they exit from the apparatus.
- 11 Only use attachments/accessories specified by the manufacturer.
- 12 Use only with the cart, stand, tripod, bracket, or table specified by the manufacturer, or sold with the apparatus. When a cart is used, use caution when moving the cart/apparatus combination to avoid injury from tip-over.
- 13 Unplug this apparatus during lightning storms or when unused for long periods of time.
- 14 Refer all servicing to qualified service personnel. Servicing is required when the apparatus has been damaged in any way, such as power-supply cord or plug is damaged, liquid has been spilled or objects have fallen into the apparatus, the apparatus has been exposed to rain or moisture, does not operate normally, or has been dropped.



We Want You Listening For A Lifetime

Yamaha and the Electronic Industries Association’s Consumer Electronics Group want you to get the most out of your equipment by playing it at a safe level. One that lets the sound come through loud and clear without annoying blaring or distortion – and, most importantly, without affecting your sensitive hearing. Since hearing damage from loud sounds is often undetectable until it is too late, Yamaha and the Electronic Industries Association’s Consumer Electronics Group recommend you to avoid prolonged exposure from excessive volume levels.



FCC INFORMATION (for US customers)

1 IMPORTANT NOTICE: DO NOT MODIFY THIS UNIT!

This product, when installed as indicated in the instructions contained in this manual, meets FCC requirements. Modifications not expressly approved by Yamaha may void your authority, granted by the FCC, to use the product.

2 IMPORTANT:

When connecting this product to accessories and/or another product use only high quality shielded cables. Cable/s supplied with this product MUST be used. Follow all installation instructions. Failure to follow instructions could void your FCC authorization to use this product in the USA.

3 NOTE:

This product has been tested and found to comply with the requirements listed in FCC Regulations, Part 15 for Class "B" digital devices. Compliance with these requirements provides a reasonable level of assurance that your use of this product in a residential environment will not result in harmful interference with other electronic devices.

This equipment generates/uses radio frequencies and, if not installed and used according to the instructions found in the users manual, may cause interference harmful to the operation of other electronic devices.

Compliance with FCC regulations does not guarantee that interference will not occur in all installations. If this product is found to be the source of interference, which can be determined by turning the unit "OFF" and "ON", please try to eliminate the problem by using one of the following measures:

Relocate either this product or the device that is being affected by the interference.

Utilize power outlets that are on different branch (circuit breaker or fuse) circuits or install AC line filter/s.

In the case of radio or TV interference, relocate/reorient the antenna. If the antenna lead-in is 300 ohm ribbon lead, change the lead-in to coaxial type cable.

If these corrective measures do not produce satisfactory results, please contact the local retailer authorized to distribute this type of product. If you can not locate the appropriate retailer, please contact Yamaha Electronics Corp., U.S.A. 6660 Orangethorpe Ave., Buena Park, CA 90620.

The above statements apply ONLY to those products distributed by Yamaha Corporation of America or its subsidiaries.

CAUTION

Use of controls or adjustments or performance of procedures other than those specified herein may result in hazardous radiation exposure.

AVERTISSEMENT

L'utilisation de commandes et l'emploi de réglages ou de méthodes autres que ceux décrits ci-dessous, peuvent entraîner une exposition à un rayonnement dangereux.

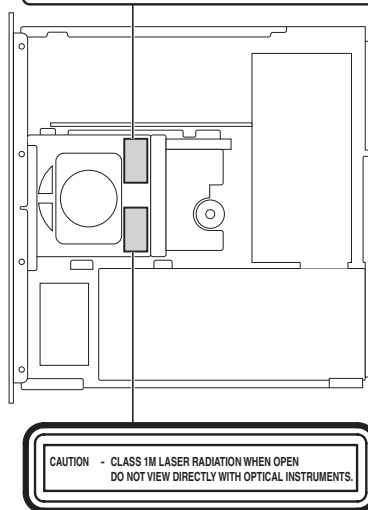
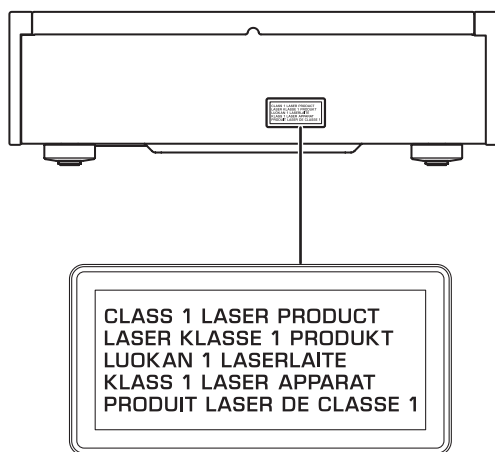

CAUTION CLASS 1M LASER RADIATION WHEN OPEN DO NOT VIEW DIRECTLY WITH OPTICAL INSTRUMENTS.

* This label is attached only to the U.K. and Europe models.

Caution: Read this before operating your unit.

- 1 To assure the finest performance, please read this manual carefully. Keep it in a safe place for future reference.
- 2 Install this sound system in a well ventilated, cool, dry, clean place – away from direct sunlight, heat sources, vibration, dust, moisture, and/or cold. Allow ventilation space of at least 10 cm on the top, 10 cm on the left and right, and 10 cm on the back of this unit.
- 3 Locate this unit away from other electrical appliances, motors, or transformers to avoid humming sounds.
- 4 Do not expose this unit to sudden temperature changes from cold to hot, and do not locate this unit in an environment with high humidity (i.e. a room with a humidifier) to prevent condensation inside this unit, which may cause an electrical shock, fire, damage to this unit, and/or personal injury.
- 5 Avoid installing this unit where foreign objects may fall onto this unit and/or this unit may be exposed to liquid dripping or splashing. On the top of this unit, do not place:
 - Other components, as they may cause damage and/or discoloration on the surface of this unit.
 - Burning objects (i.e. candles), as they may cause fire, damage to this unit, and/or personal injury.
 - Containers with liquid in them, as they may fall and liquid may cause electrical shock to the user and/or damage to this unit.
- 6 Do not cover this unit with a newspaper, tablecloth, curtain, etc. in order not to obstruct heat radiation. If the temperature inside this unit rises, it may cause fire, damage to this unit, and/or personal injury.
- 7 Do not plug in this unit to a wall outlet until all connections are complete.
- 8 Do not operate this unit upside-down. It may overheat, possibly causing damage.
- 9 Do not use force on switches, knobs and/or cords.
- 10 When disconnecting the power cable from the wall outlet, grasp the plug; do not pull the cable.
- 11 Do not clean this unit with chemical solvents; this might damage the finish.
- 12 Only voltage specified on this unit must be used. Using this unit with a higher voltage than specified is dangerous and may cause fire, damage to this unit, and/or personal injury. Yamaha will not be held responsible for any damage resulting from use of this unit with a voltage other than specified.
- 13 To prevent damage by lightning, keep the power cord disconnected from a wall outlet or the unit during a lightning storm.
- 14 Do not attempt to modify or fix this unit. Contact qualified Yamaha service personnel when any service is needed. The cabinet should never be opened for any reasons.
- 15 When not planning to use this unit for long periods of time (i.e. vacation), disconnect the AC power plug from the wall outlet.
- 16 Install this unit near the AC outlet and where the AC power plug can be reached easily.
- 17 Be sure to read the “Troubleshooting” section in the owner’s manual on common operating errors before concluding that this unit is faulty.
- 18 Before moving this unit, press POWER downward to turn off this unit and then disconnect the AC power plug from the AC wall outlet.
- 19 **VOLTAGE SELECTOR** (Asia and General models only)
The VOLTAGE SELECTOR on the rear panel of this unit must be set for your local main voltage BEFORE plugging into the AC wall outlet. Voltages are:
.....AC 110/120/220/230–240 V, 50/60 Hz
- 20 The batteries shall not be exposed to excessive heat such as sunshine, fire or like.

As long as this unit is connected to the AC wall outlet, it is not disconnected from the AC power source even if you turn off this unit by POWER.

WARNING
TO REDUCE THE RISK OF FIRE OR ELECTRIC SHOCK, DO NOT EXPOSE THIS UNIT TO RAIN OR MOISTURE.

LASER SAFETY
This unit employs a laser. Due to possible eye injury, only a qualified service person should remove the cover or attempt to service this device.

DANGER
This unit emits visible laser radiation when open. Avoid direct eye exposure to beam. When this unit is plugged into the wall outlet, do not place your eyes close to the opening of the disc tray and other openings to look into inside.

The laser component in this product is capable of emitting radiation exceeding the limit for Class 1.

This symbol mark is according to the EU directive 2002/96/EC.



This symbol mark means that electrical and electronic equipment, at their end-of-life, should be disposed of separately from your household waste. Please act according to your local rules and do not dispose of your old products with your normal household waste.

■ Notes on batteries

- Change all of the batteries if you notice that the operation range of the remote control decreases.
- Use AA, R6, UM-3 batteries.
- Make sure that the polarities are correct. See the illustration inside the battery compartment.
- Remove the batteries if the remote control is not used for an extended period of time.
- Do not use old batteries together with new ones.
- Do not use different types of batteries (such as alkaline and manganese batteries) together. Read the packaging carefully as these different types of batteries may have the same shape and color.
- If the batteries have leaked, dispose of them immediately. Avoid touching the leaked material or letting it come into contact with clothing, etc. Clean the battery compartment thoroughly before installing new batteries.
- Do not throw away batteries with general house waste; dispose of them correctly in accordance with your local regulations.

■ For U.K. customers

If the socket outlets in the home are not suitable for the plug supplied with this appliance, it should be cut off and an appropriate 3 pin plug fitted. For details, refer to the instructions described below.

Note

The plug severed from the mains lead must be destroyed, as a plug with bared flexible cord is hazardous if engaged in a live socket outlet.

■ Handling the remote control

- The area between the remote control and this unit must be clear of large obstacles.
- Do not spill water or other liquids on the remote control.
- Do not drop the remote control.
- Do not leave or store the remote control in the following types of conditions:
 - places of high humidity, such as near a bath
 - places of high temperature, such as near a heater or a stove
 - places of extremely low temperatures
 - dusty places
- Do not expose the remote control sensor to strong lighting, in particular, an inverter type fluorescent lamp; otherwise, the remote control may not work properly. If necessary, position this unit away from direct lighting.

■ Special Instructions for U.K. Model

IMPORTANT

THE WIRES IN MAINS LEAD ARE COLOURED IN ACCORDANCE WITH THE FOLLOWING CODE:

Blue: NEUTRAL

Brown: LIVE

As the colours of the wires in the mains lead of this apparatus may not correspond with the coloured markings identifying the terminals in your plug, proceed as follows:

The wire which is coloured BLUE must be connected to the terminal which is marked with the letter N or coloured BLACK. The wire which is coloured BROWN must be connected to the terminal which is marked with the letter L or coloured RED.

Making sure that neither core is connected to the earth terminal of the three pin plug.

Limited Guarantee for European Economic Area (EEA) and Switzerland

Thank you for having chosen a Yamaha product. In the unlikely event that your Yamaha product needs guarantee service, please contact the dealer from whom it was purchased. If you experience any difficulty, please contact Yamaha representative office in your country. You can find full details on our website (<http://www.yamaha-hifi.com/> or <http://www.yamaha-uk.com/> for U.K. resident).

The product is guaranteed to be free from defects in workmanship or materials for a period of two years from the date of the original purchase. Yamaha undertakes, subject to the conditions listed below, to have the faulty product or any part(s) repaired, or replaced at Yamaha's discretion, without any charge for parts or labour. Yamaha reserves the right to replace a product with that of a similar kind and/or value and condition, where a model has been discontinued or is considered uneconomic to repair.

Conditions

1. The original invoice or sales receipt (showing date of purchase, product code and dealer's name) MUST accompany the defective product, along with a statement detailing the fault. In the absence of this clear proof of purchase, Yamaha reserves the right to refuse to provide free of charge service and the product may be returned at the customer's expense.
2. The product MUST have been purchased from an AUTHORISED Yamaha dealer within the European Economic Area (EEA) or Switzerland.
3. The product must not have been the subject of any modifications or alterations, unless authorised in writing by Yamaha.
4. The following are excluded from this guarantee:
 - a. Periodic maintenance and repair or replacement of parts due to normal wear and tear.
 - b. Damage resulting from:
 - (1) Repairs performed by the customer himself or by an unauthorised third party.
 - (2) Inadequate packaging or mishandling, when the product is in transit from the customer. Please note that it is the customer's responsibility to ensure the product is adequately packaged when returning the product for repair.
 - (3) Misuse, including but not limited to (a) failure to use the product for its normal purpose or in accordance with Yamaha's instructions on the proper use, maintenance and storage, and (b) installation or use of the product in a manner inconsistent with the technical or safety standards in force in the country where it is used.
 - (4) Accidents, lightning, water, fire, improper ventilation, battery leakage or any cause beyond Yamaha's control.
 - (5) Defects of the system into which this product is incorporated and/or incompatibility with third party products.
 - (6) Use of a product imported into the EEA and/or Switzerland, not by Yamaha, where that product does not conform to the technical or safety standards of the country of use and/or to the standard specification of a product sold by Yamaha in the EEA and/or Switzerland.
 - (7) Non AV (Audio Visual) related products.
(Products subject to "Yamaha AV Guarantee Statement" are defined in our website at <http://www.yamaha-hifi.com/> or <http://www.yamaha-uk.com/> for U.K. resident.)
5. Where the guarantee differs between the country of purchase and the country of use of the product, the guarantee of the country of use shall apply.
6. Yamaha may not be held responsible for any losses or damages, whether direct, consequential or otherwise, save for the repair or replacement of the product.
7. Please backup any custom settings or data, as Yamaha may not be held responsible for any alteration or loss to such settings or data.
8. This guarantee does not affect the consumer's statutory rights under applicable national laws in force or the consumer's rights against the dealer arising from their sales/purchase contract.



© 2008 YAMAHA CORPORATION All rights reserved.

YAMAHA ELECTRONICS CORPORATION, USA 6660 ORANGETHORPE AVE., BUENA PARK, CALIF. 90620, U.S.A.
YAMAHA CANADA MUSIC LTD. 135 MILNER AVE., SCARBOROUGH, ONTARIO M1S 3R1, CANADA
YAMAHA ELECTRONIK EUROPA G.m.b.H. SIEMENSSTR. 22-34, 25462 RELLINGEN BEI HAMBURG, GERMANY
YAMAHA ELECTRONIQUE FRANCE S.A. RUE AMBROISE CROIZAT BP70 CROISSY-BEAUBOURG 77312 MARNE-LA-VALLEE CEDEX02, FRANCE
YAMAHA ELECTRONICS (UK) LTD. YAMAHA HOUSE, 200 RICKMANSWORTH ROAD WATFORD, HERTS WD18 7GQ, ENGLAND
YAMAHA SCANDINAVIA A.B. J A WETTERGRENS GATA 1, BOX 30053, 400 43 VÄSTRA FRÖLUNDA, SWEDEN
YAMAHA MUSIC AUSTRALIA PTY. LTD. LEVEL 1, 99 QUEENSBRIDGE STREET, SOUTHBANK, VIC 3006, AUSTRALIA

YAMAHA CORPORATION
Printed in Malaysia © WN63220